

Dear customer,

Motorola M800 Bag Phone was designed as a carry-case solution, which enables clients in a variety of industries such as: Oil and Gas, Agriculture and Forestry to stay connected while on the job or in the field. With its ease of portability, large, widely spaced keypad, high resolution display, voice activation feature and all round hands-free environments, the M800 Bag Phone is the more convenient way to talk, work and travel.

Key Product Features

- Stay connected no matter the circumstances. The M800 Bag Phone provides extended power output support for high-level network coverage, internal antenna for use in an office and on the move, or an optional external antenna for use in vehicles and boats.
- The M800 Bag Phone offers multiple power sources support, for use with a cigarette lighter adaptor, wall socket charger or a rechargeable battery.
- The M800 Bag Phone, together with Motorola's MPT program provides high-speed data transmission such as E-mails, faxes and files.
- The M800 Bag Phone provides the ability to access its functionality by speaking to the phone in English or French Canadian. Voice activation features include: name dialing, which enables you to speak a voice tag that you have saved for a phonebook entry; number dialing, which lets you speak a phone number for the M800 Bag Phone to dial; and voice activated menu access, which allows you to browse to frequently used menu options by attaching voice tags to them.
- The M800 Bag Phone high quality hands-free operation enables you to communicate in a more convenient way while in a traveling environment. With its innovative noise and echo suppression, the M800 Bag Phone provides natural sound quality and eliminates intrusive noise, allowing the user to hear clearly and be heard without effort or interference.
- The Bag Phone's enhanced illuminated graphic display is designed for easy reading using 8 mm character height, with an adjustable backlight and contrast display setting.
- A well-spaced keypad with large, illuminated tactile keys makes it easier for you to dial when mobile.

* Various phone features are network dependant.

** Specifications subject to change without prior notice.

Total Customer Satisfaction

Absolute customer satisfaction is Motorola's top priority. If you have a question, suggestion or any other issue concerning the Motorola M800 Bag Phone, Motorola wants to hear from you.

Motorola Australia Customer Care	1300138 823 8am – 6pm Australia EST
Motorola New Zealand Customer Care	0508 668-676 10am - 8pm
Motorola Canada Customer Care	1-800-461-4575
Motorola USA Customer Care	866-289-6866

MOTOROLA, the Stylized M Logo and all other trademarks indicated as such herein are trademarks of Motorola, Inc.® Reg.U.S. Pat.&Tm.Off. TrueSync, Sidekick, Starfish and the Stylized Starfish Logo are registered trademarks of Starfish Software, Inc., a wholly owned independent subsidiary of Motorola, Inc. All other product or service names are the property of their respective owners.

©2005 Motorola, Inc. All rights reserved.

Software Copyright Notice

The Motorola products described in this manual, may include copyrighted Motorola and third party software stored in semiconductor memories or other media. Laws in the United States and other countries preserve for Motorola and third party software providers certain exclusive rights for copyrighted software, such as the exclusive rights to distribute or reproduce the copyrighted software. Accordingly, any copyrighted software contained in the Motorola products may not be modified, reverse-engineered, distributed, or reproduced in any manner to the extent allowed by law. Furthermore, the purchase of the Motorola products shall not be deemed to grant either directly or by implication, estoppel, or otherwise, any license under the copyrights, patents, or patent applications of Motorola or any third party software provider, except for the normal, non-exclusive, royalty-free license to use that arises by operation of law in the sale of a product.

WELCOME

Welcome to the world of Motorola digital wireless Communications!
We are pleased that you have decided to choose the Motorola M800 Bag Phone.

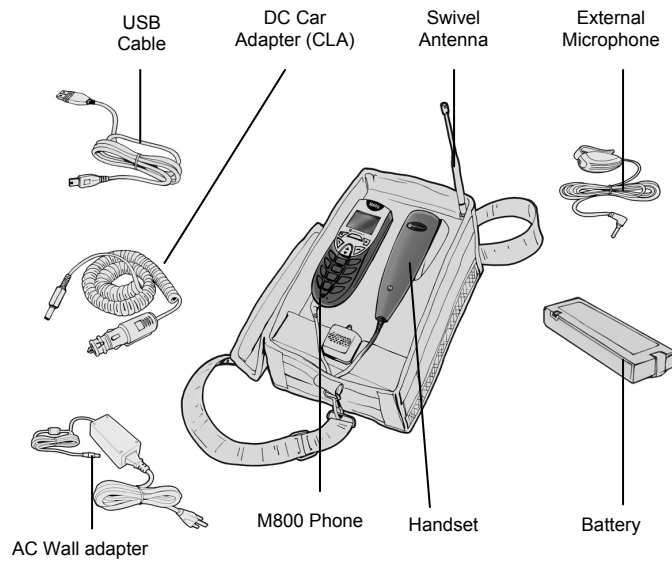

Table of Contents

Total Customer Satisfaction	1
Software Copyright Notice	2
WELCOME	3
Table of Contents	4
About This Guide	7
Getting Started	7
The Bag	7
The Handset	10
Battery Compartment	11
Swivel Antenna	12
Accessories	13
External Microphone	13
Power Adaptors	14
Optional Accessories	15
Using The Phone	16
Navigating To a Menu Feature	17
Menu Map	18
Main Menu	18
Settings	19
Getting Started	22
Turning Your Phone On	22
Making a Call	22
Ending a Call	23
Answering a Call	23
Seeing Your Phone Number	23
Using Your Phone	24
Phone Display	24
Zooming In and Out	26
Adjusting Volume	26
Making and Answering Calls	27
Redialing a Number	27
Using Automatic Redial	27
Using Caller ID	28
Viewing the Received Calls or Dialed Calls List	28
Calling an Emergency Number	29
Automatic Location Information	30
Canceling an Incoming Call	31
Calling with Speed Dial	31
Calling with One-Touch Dial	31
Using Features While On a Call	34
Using Call Waiting	34
Making a Three-Way Call	34
Additional On-Call Features	35

Using Menus	36
Navigating to a Feature	36
Entering Text	40
Choosing a Text Mode	40
Using Tap Method: English/French Canadian	40
Using Symbol Mode	43
Using iTAP™ Software Predictive Text Entry Method	44
Menu Feature Descriptions	48
Main Menu	48
Settings Menu	52
Recent Calls	58
Viewing Received Calls or Dialed Calls	58
Last Number Entered	59
Viewing and Resetting Call Timers	60
Phonebook	62
Viewing Entry Details	62
Storing a Phonebook Entry	62
Storing a Split Number	64
Recording a Voice Name For a Phonebook Entry	65
Dialing a Phonebook Entry	66
Editing a Phonebook Entry	67
Sorting the Phonebook List	68
Icon Viewer	69
Datebook	70
Week View	70
Day View	71
Event View	71
Adding a Datebook Event	71
Changing Event Information	72
Copying an Event	73
Deleting an Event	74
Messages – Voicemail	75
Storing Your Voicemail Number	75
Receiving a Voicemail Message	75
Listening to a Voicemail Message	76
Canceling the “Voice Message” indicator	76
Messages – Text	77
Setting up the Text Message Inbox	77
Receiving a Text Message	77
Reading, Locking, or Deleting a Text Message	78
Sending a Text Message	79
Sending a Quick Note Text Message	82
Viewing the Status of Sent Text Messages	82
Ring Styles	83
Customizing a Ring Style	83
Activate and Deactivate Ringer IDs	83
Set Ringer or Keypad Volume	84

Creating Alert Tones	84
Setting Reminders	89
Shortcuts	90
Standard Shortcuts	90
Creating a Shortcut	90
Using Shortcuts	91
VoiceNotes™	92
Recording a VoiceNote™	92
Viewing the VoiceNotes™ List	93
Playing a VoiceNote™	93
VoiceNote™ Controls	95
Locking a VoiceNote™	96
Deleting a VoiceNote™	97
Voice Activation	98
Dialing Names	98
Voice-Activated Speed Dialing	99
Dialing Digits	100
Voice Shortcuts to Features	100
Micro-Browser	101
Starting a Micro-Browser Session	101
Using Web Pages	101
Calculator	102
Calculating Actions	102
Converting Currency	103
Adjusting Your Settings	104
Reordering Menu Items	104
Customizing a Soft Key Function	104
Screen Saver	105
Data and Fax Calls	106
Sending a Data or Fax Call	107
Receiving a Data or Fax Call	107
Security	109
Assigning a New Code or Password	109
If You Forget a Code or Password	110
Locking and Unlocking Your Phone	110
Troubleshooting	112
Safety and General Information	116
Wireless Phone Safety Tips	119

About This Guide

This user guide introduces you to the components and features of your Bag Phone.

Getting Started

The Bag

The Motorola M800 Bag Phone bag contains the bag phone set in a portable, easy to carry manner.

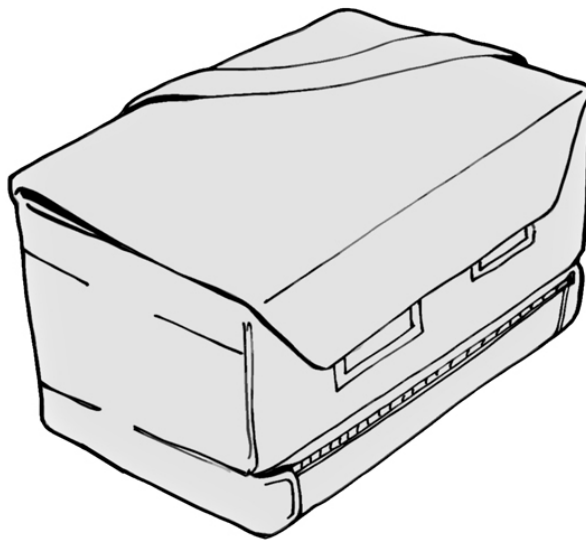

The bag's chassis contains the following elements:

- Connector panel
- LED and buzzer indicators

Also attached to the bottom of the bag is an accessory pouch.

Connector Panel

The connector panel is used to connect various elements to the Phone Bag. These elements are:

- External DC power source connector
- External Microphone connector
- MINI USB cable connector

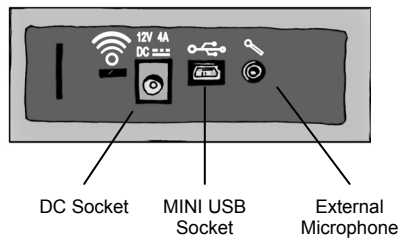

LED and Buzzer Indicators

The LED and buzzer indicators are used to indicate the status of the battery, and the connection or disconnection of the external microphone or power supply.



LED status	Description
Steady Green	Working from CLA or AC power supply and not charging.
Blinking Orange and Green	Charging
Blinking Red	Low battery
Blinking Green	Supply voltage from back up battery



Buzzer

<i>Beep type</i>	<i>Description</i>
High pitch beep	Low battery
Medium pitch beep	External Microphone connected or disconnected
Low pitch beep	External DC supply connected or disconnected

Safety Belt

To Mount and firmly locate the bag when driving, the bag has two optional seat belt loops through which you can slide and lock your passenger's seat safety belt.

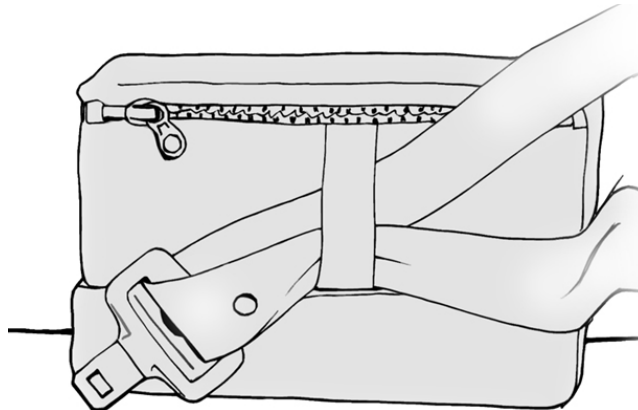

The Handset

The Motorola personal handset enables you to conduct private conversations and use the voice activation dialing features. Pressing the PTT button on the handset invokes the VAD name and number dialing features.

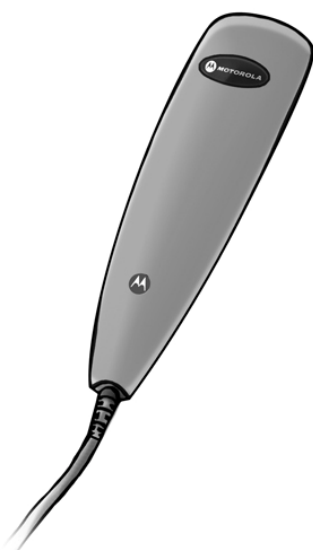

To use the handset:

- 1 Pick up the handset.
- 2 Press the PTT twice for number dialing and once for name dialing.
- 3 End conversations via the PTT button on the handset.

Note: If the handset is not hooked to the cradle, an incoming call will not be heard.

Battery Compartment

The Motorola M800 Bag Phone contains a Battery compartment for the backup battery.

To replace a battery:

- 1 Unzip the battery compartment zipper.
- 2 Pull the battery out of its compartment and then out of its box.
- 3 Disconnect the battery from its connector.
- 4 Connect the new battery to the connector and replace it in its box and compartment.
- 5 Zip the battery compartment zipper.

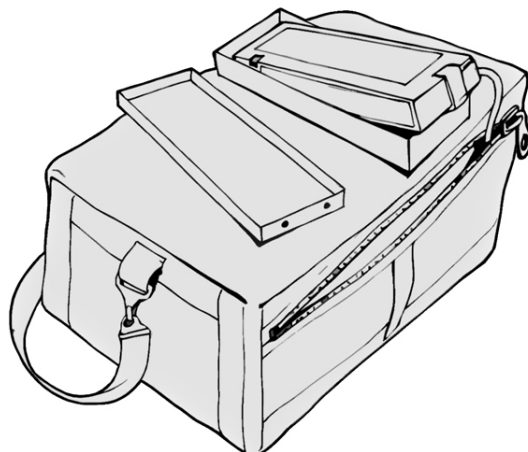

Swivel Antenna

The Motorola M800 Bag Phone contains a swivel antenna.

Before placing a call, or when unit is expecting a call:

- 1 Open the bag's cover.
- 2 Straighten the antenna.

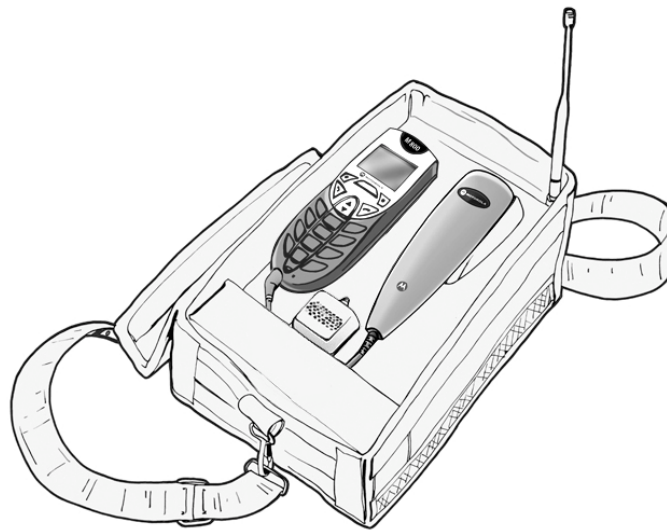

Accessories

External Microphone

The M800 Bag Phone offers an external microphone for use in your car.
To connect the external microphone:

- 1 Connect the external microphone to the microphone connector located on the connector panel. Place the cable in the Velcro loop to make sure the connector won't come out.
- 2 Slide the external microphone clip on your driver seat's visor. Locate the external microphone away from the car window to avoid background noise.

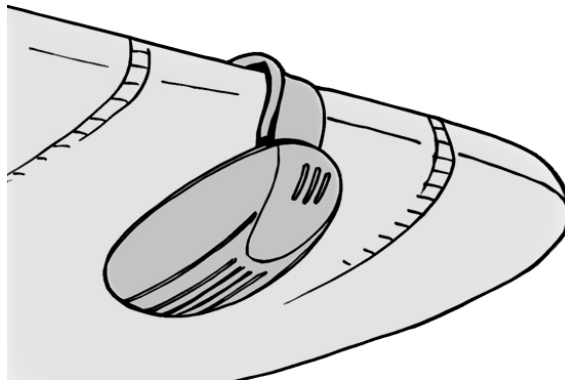

Power Adaptors

The M800 Bag Phone offers two different manners of external power connection.

CLA Power Adaptor

The CLA power adaptor allows you to connect the M800 Bag Phone to your car's cigarette lighter adaptor.

To use the M800 Bag Phone with your car's cigarette lighter adaptor, connect the adaptor to the DC socket in the Connector panel. Place the cable in the Velcro loop to make sure the connector DC jack won't come out.

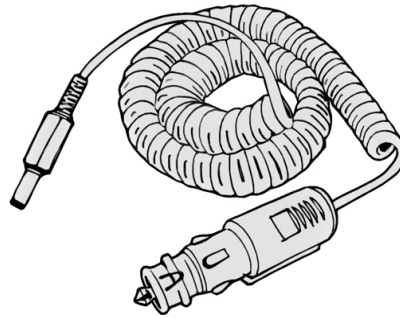

Wall Socket Power Adaptor

The wall socket power adaptor allows you to connect the M800 Bag Phone to your wall socket adaptor.

To use the M800 Bag Phone with your Wall Socket Power Adaptor, connect the adaptor to the DC socket in the Connector panel. Place the cable in the Velcro loop to make sure the connector DC jack won't come out.

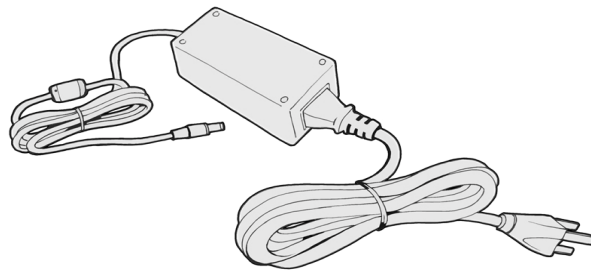

Optional Accessories

Motorola advises use of original accessories of its manufacture. It is emphasized that the warranty provided for the phone is invalid in cases where the fault was caused by connection to equipment and/or devices that are not original or approved by Motorola for distribution (paragraph 6 of the warranty). Original accessories are at your disposal and available for purchase from authorized outlets. Please contact your network service provider for information on the availability of accessories and their purchase.

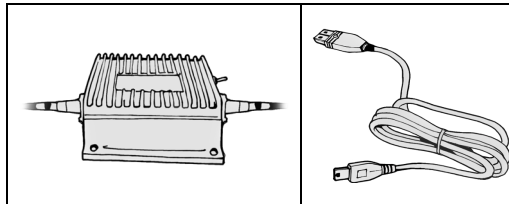

Booster

MINI USB cable

- The MINI USB Cable is used to send and receive data and fax calls to your portable computer.
- The Booster is used to boost the unit's transmission.

Using The Phone



This section introduces you to the many features of your Bag Phone's M800 mobile phone.



Navigating To a Menu Feature

Use the menu system to access your phone's features. This guide shows you how to select a menu feature as follows:

Find The Feature  > Messages
> New Message

In this example, you must press  scroll using  to **Messages** features and select it using  (Select), and subsequently scroll to the **New Message** option and select it.

Optional Features



This label identifies an optional network or subscription-dependent feature that may be contingent upon payment. Possibly not all service providers offer these features in all geographical areas. Contact your service provider for more information about the availability of these features.

Optional Accessories



This label identifies a feature that requires an optional Motorola Original™ accessory available for purchase separately. Please contact your service provider for information about the availability and purchase of these devices.

Menu Map

Main Menu

- **Phonebook**
- **Search**
- **Recent Calls**
 - Received Calls
 - Dialed Calls
 - Notepad
 - Call times
 - Data times
 - Data volumes
- **Messages**
 - Voicemail
 - Create Message
 - Inbox
 - Outbox
 - Quick Notes
 - Drafts
 - Browser Alerts
- **Browser**
- **Settings**
- **Icon Viewer**
- **Shortcuts**
- **Calculator**
- **Datebook**
- **VoiceNotes™**

(see page 51)

Settings

- **Ring Styles**
 - Loud Detail
 - My Tones
- **Phone status**
 - My Tel. Number
 - Other Information
- **Browser Setup**
- **Connection**
 - Incoming Call
- **In-Call Setup**
 - In-Call Timer
 - Answer Options
- **Security**
 - Phone Lock
 - Lock Application
 - New Passwords
- **Location**
 - Location on
- **Voice Activation**
 - Language
 - Voice Comments
 - Training

Other Settings

➤ **Personalize**

- Main Menu
- Keys
- Greeting
- Screen Saver
- Banner

➤ **Initial Setup**

- Auto PIN Dial
- Automatic Redial
- Backlight
- Zoom
- Scroll
- Animation
- Language
- Contrast
- DTMF
- Master Reset
- Master Clear

➤ **Network**

- Current Network



➤ **Car Settings**

- Auto Answer

These are the standard shortcut menus in the telephone device.

Shortcuts

Display my telephone number:

Press   (Display the name - pressing the right soft key  displays the number).

Dialing Voicemail:

Press and hold 

Go to the dialed calls list:

Press 

Exit the menu system:

Press 

Volume:



During a call, press the volume keys on the side of the device.

Ringer volume:



On the standby display, press the volume keys on the side of the device.

Getting Started

Turning Your Phone On

Do this	To
1 Press and hold  for 3 seconds	Turn on your phone
 On/Off Key	
2 If required, key in the 4-digit unlock code and press OK ()	Unlock the phone The unlock code is set to the last 4 digits of your phone number.
3 While switching the vehicle on/off (using the ignition switch), the device will turn on	

Making a Call

Do this	To
1 Press the keypad keys	Dial the phone number
	Tip: If you made a mistake, press DELETE () to delete the last digit, or press and hold DELETE () to clear all digits.
2 Press 	Make the call

Ending a Call

Press	To
 or the voice activation key	End the call



Answering a Call

When you receive a call, your phone rings and/or lights up and displays an incoming call message.

Press	To
 or press ANSWER or  press the voice activation key	Answer the call

Note: if your phone is locked, you must unlock it to answer the call.

Seeing Your Phone Number

Press	To
 	See your phone number



Using Your Phone

See page 16 for a basic phone diagram.

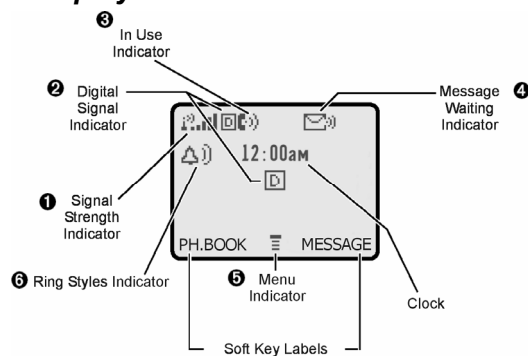
Phone Display



The *idle display* is the standard display that you see when you are not on a call or using the menu.

Labels at the bottom corners of the display show the current functions of the soft keys. A  (menu) indicator at the bottom center of the display indicates that you can press  to enter the main menu.

- 1** **Signal Strength Indicator** vertical bars show the strength of the network connection. You cannot make or receive calls when the  (no signal) indicator is displayed.



- 2** **Digital Signal Indicator**  identifies a digital network.

- 3** **In Use Indicator** shows that a call is in progress.



4 **Message Waiting Indicator** appears when you receive voicemail or a text message.

5 **Menu Indicator** indicates that you can press  to enter the main menu or open a feature sub-menu.

6 **Ring Style Indicator**

 = Loud Detail
My Tones

Zooming In and Out

You can zoom in and out to display more information on the screen.

Find The Feature



> Settings
> Other Settings
> Initial Setup > Zoom

Adjusting Volume

Press the up and down volume keys to:

- Increase and decrease call volume in external speaker or handset during a call.
- Increase and decrease the ringer volume when the idle display is visible.

Volume
Keys





Making and Answering Calls

For basic instructions on how to make a call, end a call, or answer a call, see page 23.

Redialing a Number

If you hear an ordinary busy signal:

Press	To
1 	Hang up
2 	Redial the busy number

Using Automatic Redial

If the network is busy, you hear a fast busy signal, and your phone displays **Call Failed**.

With automatic redial, your phone automatically redials the number for four minutes. When the call goes through, your phone rings one time, displays **Redial Successful**, and then connects the call.

You must turn on automatic redial to use the feature. See the “Auto Redial” option on page 55.

When automatic redial is turned off, you can manually activate the feature to redial a phone number. When you hear a fast busy signal and see **Call Failed**:

Press	To
 twice	Activate automatic redial

Using Caller ID



Calling line identification (caller ID) displays the phone numbers for incoming calls to your phone.

The phone displays the caller's name when the name is stored in your phonebook, or **Unknown Call** when caller ID information is not available.

Returning an Unanswered Call

Your phone keeps a record of your unanswered calls, and displays the following items:

- indicator (missed call).
- **X Missed Calls Y Unknown**, where X is the total number of missed calls and Y is the number of missed calls with no caller ID information.

Press	To
1 DISPLAY ()	See the received calls list
2	Select a call to return
3	Make the call



Viewing the Received Calls or Dialed Calls List

Your phone keeps lists of the calls you recently received and dialed, even if the calls did not connect. The lists are sorted from newest to oldest, and contain up to 10 entries. The oldest entries are deleted as new ones are added.

Shortcut: From the idle display, press to display the dialed calls list.

Find The Feature > Recent Calls

Press	To
1 up or down	Scroll to Received Calls or Dialed Calls
2 SELECT ()	Select the list
3	Scroll to an entry Note: The symbol means the call is connected.
4	Call the entry's number

Press	To
	Note: Press and hold  for 2 seconds to send the number as DTMF tones during a call.
or	
	

Calling an Emergency Number

Your service provider programs one or more emergency phone numbers, such as 911, so that you can call under any circumstances, even when your phone is locked.

Note: Emergency numbers vary by country. Your phone's preprogrammed emergency number(s) may not work in all locations, and sometimes an emergency call cannot be placed due to problems in the network or other interference issues.

Press	To
1 keypad keys	Dial the emergency number
2 	Call the emergency number

Automatic Location Information

Automatic Location Information:



ALI Indicator Shows the status of the automatic location information feature:

= ALI on = ALI off

LOCATION



Hiding or Showing Location Information

The Automatic Location Information (ALI) feature is capable of updating the network where you are physically located. This feature is only available in certain models.



When ALI is set to **Location On**, your phone displays the (ALI on) indicator. Services may use your known location to provide useful information (for example, driving directions, or the location of the nearest bank). Your phone prompts you when the network or a service asks for your location. You can refuse at this point.

When ALI is set to **911 Only**, your phone displays the (ALI off) Indicator, and the phone does not send location information unless you call the emergency phone number (such as 911).



Find The Feature



Press	To
1	Scroll to Location On or 911 Only
2 SELECT	Select the setting

Canceling an Incoming Call

While the phone is ringing or alerting:

Press	To
 or IGNORE 	Cancel the incoming call



Depending on your phone settings and/or service subscription, the call may be forwarded to another number, or the caller may hear a busy signal.

Calling with Speed Dial

Each entry you store in your phonebook is assigned a unique *speed dial* number, which identifies the stored location of the entry in the phone memory. To speed dial a phonebook entry:

Press the digits of the phonebook entry you want to call. Hold the last digit continuously until the number dials.

For example:

- To dial phonebook entry 99, press 9 and then long press on 9.
- To dial phonebook entry 7, long press on number 7.

You must hold down the last digit of the phonebook entry for this feature to work, even if it is just a single digit.

Calling with One-Touch Dial



To call phonebook entries 1 through 9, just press and hold the one-digit speed dial number for one second.

We recommend that you reserve phonebook entry 1 (speed dial number 1) for storing and dialing your voicemail number (Voicemail service of the service provider). In many cases, your service provider has already done this for you. If necessary, see page 75 to store your voicemail number for one-touch dial access.

Calling a Number in a Text Message





Calling a Number in a Text Message

To call a phone number embedded in a text message that you receive, highlight or open the message and then:



Press	To
1 	Open the Inbox Menu
2 	Scroll to Call Back
3 SELECT 	Call the number

Additional Calling Features

While dialing (with digits visible in the display), open the **Dialing Menu** to perform the following tasks:

Press	To
1  > Attach Number	Attach a number from the phonebook or recent call lists
2  > Insert Pause	Insert a p (pause) character For more information, see page 65.
3  > Insert Wait	Insert a w (wait) character For more information, see page 65.
4  > Insert 'n'	Insert an n (number) character For more information, see page 65.
5  > Send Message	Open a new text message with the number in the To field

You can also call a number using these features:

Do This	To Call
1 Press and release the voice activation key, then say a voice name.	A phonebook entry using voice dial. See page 65.
 Voice Activation Key	
2 Press  > Recent Calls > Received Calls or > Dialed Calls > Entry to Call	A missed call, or a recent received or dialed call

Using Features While On a Call

Using Call Waiting



When you are on a call, an alert tone sounds to indicate that you have received a second call.

Press	To
1	Answer the new call
2	Switch back to the first call

Making a Three-Way Call



During a call, you can call and connect a third party for a three-way call. You cannot do this if you already have a call on hold.







Press	To
1 keypad keys or left soft key	Dial the third party's number View the phonebook and select the desired number
2	Call the number
3	Connect the two calls
4	End the entire call

or

Note: Some networks may use the following procedure to establish a Three-Way Call.

1. Dial the first person – wait for them to answer.
2. Dial the third person – when they answer, you may talk privately before rejoining the original call. (If your call to the third person is not successful, press 1 to return to your original caller.)
3. Join all the calls together, press 3 or to switch between callers, press 2 .

Additional On-Call Features

Press		To
1	MUTE () (if available) or  > Mute	Mute the call
2	 > My Tel. Number	See your phone number
3	 > Received Calls or Dialed Calls	View recent received or dialed call numbers
4	 > Messages	View or send messages
5	 > Datebook	View datebook entries
6	 > Other Information	View phone specifications

Using Menus

Navigating to a Feature

Use these keys to move through the menu system:

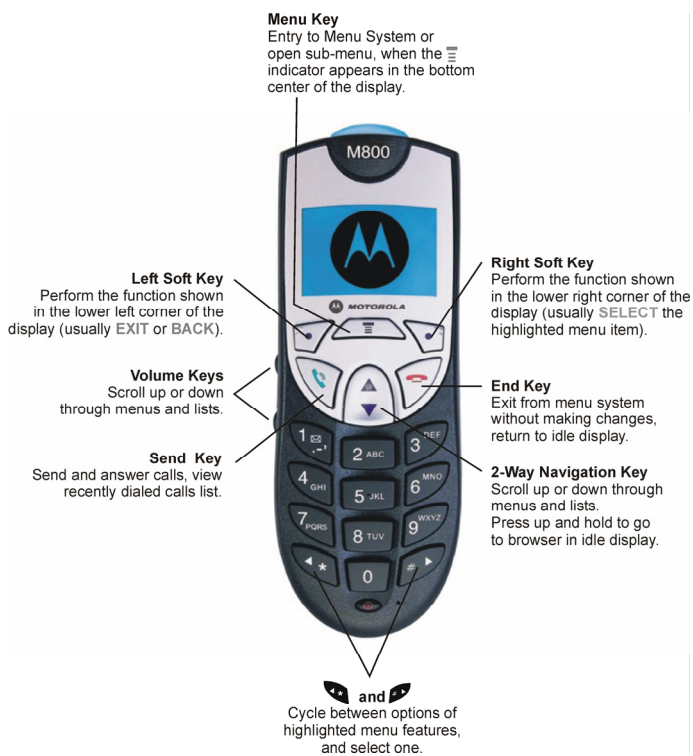

Selecting a Menu Item

Some features require you to select an item from a list:

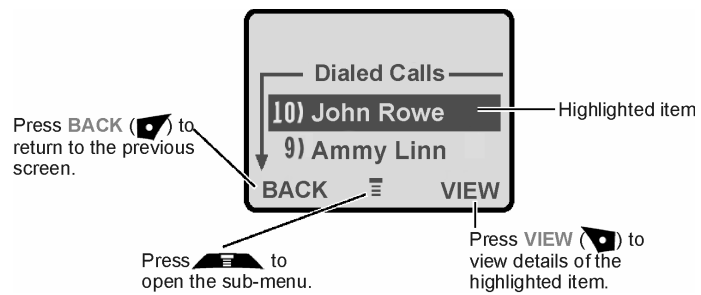

- Press ⏪ to scroll up or down and highlight the item you want.
- In a numbered list, press a number key (1-9) to highlight the item.
- In an alphabetized list, press a key multiple times to cycle through the letters on the key and highlight the closest matching list item.

Adding Information to an Item

Some features require you to enter information:

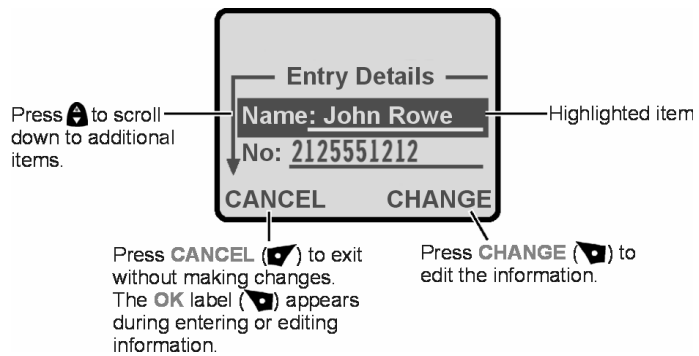

- Enter numbers or text with the keypad.
- When an item has a list of possible values, press or to the left or right to scroll through and select a value.
- When an item has a list of possible numeric values, press a number key to set the value.
- If you enter or edit information and do not want to save your changes, press to exit without saving.

The Message Center lets you compose and send text messages.
A *flashing cursor* shows where text will appear:

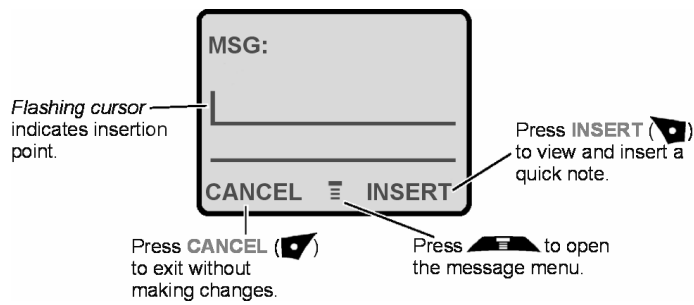

When you enter text using the standard tap method, the flashing cursor changes to a *block cursor*, and the soft key functions change:

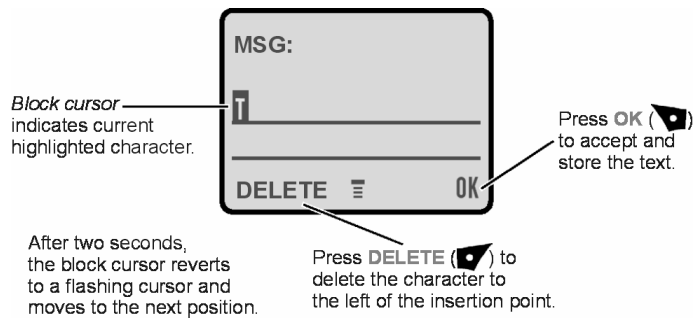



Entering Text

Multiple text entry methods make it easy for you to enter names, numbers, and messages on your phone.

Choosing a Text Mode

Press  from any text entry screen to select a text mode.

Press  and **Entry Method** appears, then press  to find the following:

**iTAP English/
French Canadian** Let the phone predict each word as you enter it. See page 44.

Tap Method Enter letters (English/French Canadian), numbers, and symbols by pressing a key one or more times. See page 42.

Numeric Enter numbers only.

Symbol Enter symbols only. See page 43.

Browse Browse your phonebook or recent call lists to select a name or number.

Note: The text mode you select remains active until you change it by selecting another mode.

Using Tap Method: English/French Canadian

This is the standard mode for entering text on your phone.

Press  from any text entry screen and select the **Tap Method** menu option.

Do This	To
1 Press a number key one or more times	Select a letter, number, or symbol shown in the "Character Chart" on page 42.
2 Continue pressing number keys	Enter the remaining characters
3 Press OK ()	Store the text when you are finished

General Text Entry Rules











Press a number key repeatedly to cycle through its characters. See "Character Chart" on page 42.



- If you do not press a key for two seconds, the character in the block cursor is accepted, and the cursor moves to the next position.
- The first character of every sentence is capitalized (while the character is highlighted by the block cursor, press  to force it to lowercase).

Character Chart



Use this chart as a guide for entering spaces, letters, numbers, and symbols with the tap method.

1 	space . 1 ? ! , @ _ & ~ : ; " - () ' ¿ ¡ % £ \$ ¥ ¢ €
2 	a b c 2 ä å á à â ã æ α β ç
3 	d e f 3 ð é é è ê ε φ
4 	g h l 4 ï ï ï ï γ η ι
5 	j k l 5 κ λ
6 	m n o 6 ñ ö ø ó ò ô μ υ ω
7 	p q r s 7 π β σ
8 	t u v 8 θ ü ú û û τ
9 	w x y z 9 ξ ψ
0 	+ - 0 x * / \ [] = > < # §

Note: This chart may not reflect the exact character set available on your phone. There may be slight variations depending on your software version.











Using Symbol Mode

Your phone provides an alternate way to enter symbol characters in a message. Press  from any text entry screen and select the **Symbol** menu option.

Do This	To
1 Press a number key one time	Display its symbol options at the bottom of the display
2 Press  or  or Press the number key multiple times	See "Symbol Chart" on page 44. Highlight the symbol you want
3 Press SELECT ()	Enter the symbol at the flashing cursor location

Symbol Chart

Use this chart as a guide for entering characters in symbol mode.

 1 ESP	space . ? ! , @ _ & ~ : ; " - () ' ¿ ¡ % £ \$ ¥ ¤ €
 2 ABC	\ _ @
 3 DEF	/ : ;
 4 GHI	" & '
 5 JKL	() [] { }
 6 MNO	¿ ¡ ~
 7 PQR	< > =
 8 TUV	\$ £ ¥ ¤ €
 9 WXYZ	# % *
 0	+ - x * / = > < # §



Using iTAP™ Software Predictive Text Entry Method

iTAP™ software provides a predictive text entry method, that lets you enter a word using one keypress per letter.

Press  from any text entry screen and select the iTAP English/ French Canadian menu option.

Note: You can switch languages within a message in iTAP text mode. Press  to select the text mode and the language you want to use.

Enter Words



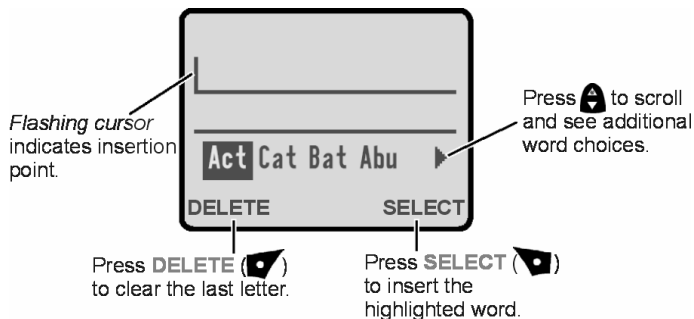

Do This	To
1 Press a number key one time	Enter the first letter of the word The letters associated with the key are shown at the bottom of the display.
2 Press number keys (one per letter)	Enter the rest of the word Alternative words and letter combinations are shown at the bottom of the display. The word choices are updated with each keypress.
3 Press  or 	Highlight the word you want
4 Press SELECT ()	Enter the word at the flashing cursor location. A space is automatically inserted after the word.

For example, to spell the word "act," press  >  > . The display shows:





Entering Novel Words

You may enter a word that the iTAP software does not recognize. If the word you want is not displayed:

Do This	To
1 Press DELETE () one or more times	Delete letters until you see a letter combination that matches the start of the word
2 Press  or 	Highlight the letter or letter combination
3 Press SELECT () then press 	Shift the text entry cursor to the left and "lock" the selected word portion
4 Continue to enter letters and highlight letter combinations	Spell the word

Punctuation



Press	To
 or 	Enter punctuation or other characters as shown in the "Character Chart" on page 42.

Entering Numbers

Do This	To
1 Enter the first digit and then highlight it	Put the iTAP software in number entry mode
2 Press number keys	Add digits to the number
3 Press SELECT ()	Enter the number at the flashing cursor location

Delete Letters and Words

Place the cursor to the right of the text you want to delete, and then do the following:

Do This	To
1 Press DELETE ()	Delete one letter at a time
2 Hold DELETE ()	Delete the entire message

Menu Feature Descriptions

This chapter describes all of your phone's features in order of the menu map shown on page 18.

Main Menu

RECENT CALLS

Received Calls



> Recent Calls
> Received Calls

View a list of recently received calls. See page 58.

Dialed Calls



> Recent Calls
> Dialed Calls

View a list of recently dialed calls. See page 58.

Notepad



> Recent Calls
> Notepad

Call or store the last number entered on the keypad. See page 59.

Call Times



> Recent Calls
> Call Times

View call timers that track time spent on your last call, dialed calls, received calls, all calls since reset, and all calls total. See page 60.

PHONEBOOK > Phonebook





Store names and numbers as entries in your phonebook, then call numbers by selecting them from the phonebook list. See page 62.

ADVANCED SEARCH > Advanced search

To improve your user experience, Motorola is pleased to introduce a fast and easy-to-use search mechanism for the telephone directory in your unit.

To search for names:

1. On the main screen, select the **Telephone Directory** menu (press **Select** or use the **Main** menu screen).
2. Press **Select** again to access the **Search** menu. A new screen opens with the message **Name**.
3. Enter one or several characters of the name you are trying to find.
4. Press **OK** (using the softkey on the right) to activate the search mechanism. If there is no name with the selected character, the screen displays the name with the next character in the alphabet. You can search for names in English and French Canadian.
5. To view the details of the contact, press **Menu** and then the **Select** softkey.

Press	Description
1 	To search for a name in the telephone directory:
2 	Access the telephone directory using the Select softkey or the Main menu.
3 	Press the softkey on the right to enter the Search menu.
4 	Enter one or more characters of the name and press OK (softkey on the right)
5 	To view details of the contact person, press Menu .
	To view the details press OK (softkey on the right).

DATEBOOK > Datebook

Use the datebook calendar to schedule and review your appointments. See page 70.

MESSAGES



> Messages

Adjust message settings, view and manage the various types of messages your phone can receive and/or send:

Voicemail	Listen to your recorded voice messages. See page 76.
Create Message	Create new text messages. See page 79.
Inbox	Read and manage text messages. See page 78.
Outbox	View all outgoing text messages.
Quick Notes	Select and send pre-written messages from the quick notes list. See page 82.
Drafts	Store and edit text messages that you have written but not sent.
Browser Alerts	Read alert messages received by your micro-browser.



SHORTCUTS  > Shortcuts

Create keypad or voice shortcuts to menu features.
See page 90.

VoiceNotes™  > VoiceNotes™

Use the voice activation key to record messages and phone calls.
See page 92.

Note: Recording phone calls is subject to varying state laws regarding privacy and recording of conversations.

BROWSER  > Browser

The micro-browser delivers WAP (Wireless Application Protocol) from your service provider directly to your phone. See page 101.



CALCULATOR  > Calculator

Use your phone as a calculator or currency converter.
See pages 102, 103.

ICON VIEWER  > Icon Viewer

View and manage the icons and animations stored on your phone. See page 69.

Settings Menu

RING STYLES

Loud Detail  > Ring Styles
> Loud detail

Change details about the current ring style. See page 83.

My Tones  > Ring Styles
> My Tones

Create custom alert tones for your phone. See page 84.

PHONE STATUS

My Tel. Number  > Settings
> Phone Status
> My Tel. Number

View, enter, and edit information about your name and phone number.

Other Information  > Settings
> Phone Status
> Other Information

View your phone's feature specifications (if available from the service provider).



CONNECTION

Connect your phone to a computer or hand-held device to send and receive data and fax calls on the connected device.



Incoming Call

 > Settings
> Connection
> Incoming Call

Specify the format for the next incoming call. You can select **Fax In Only**, **Data In Only**, or **Normal**. See page 107.

IN-CALL SETUP

Set the features that are active during a call, such as the in-call timer and call answering options.

In-Call Timer

 > Settings
> In-Call Setup
> In-Call Timer

Adjust call timer **Display and Beep** (Alert) settings. You can set your timer to beep at a selected interval during your calls. (60 seconds is the default.) You can also turn on or off a display timer during calls as follows:



Display: Time Display the elapsed time for the current call.

Beep: Off No in-call beep display.

Answer Options

 > Settings
> In-Call Setup
> Answer Options

Turn call answering options on or off:

Multi-Key Answer by pressing any key, in addition to the  key, and right soft key .

SECURITY

Phone Lock



Lock and unlock your phone. See page 110.

Lock Application



Lock and unlock specific phone applications (such as phonebook or datebook). When an application is locked, users must enter the unlock code to use the application.

New Passwords



Change your unlock code (originally set to 1234) or your security code (originally set to 000000). See page 109.

Voice Activation



OTHER SETTINGS

Personalise



Set several personal phone options:

Main Menu Change the order of the main menu. See page 104.

Keys Change the functions of the soft keys in the idle display. See page 104.

Greeting Change the text displayed when you turn on your phone.



- Screen Saver** Change the phone's screen saver image. See page 105.
- Banner** Change the text that appears in the idle display.

Initial Setup



Set many basic phone options:

- Auto PIN Dial** Some networks require an authenticating PIN code to allow outgoing calls. Use this feature to automatically dial your PIN. 
- Auto Redial** Use this option to turn on or turn off the automatic redial feature. When you turn on automatic redial, your phone automatically redials calls that fail due to busy network conditions. See page 27.
- Backlight** Set the light intensity of the display backlight and keyboard accordingly.
- Zoom** Move between three-line text display (**Zoom Out**) and two-line text display (**Zoom In**).
- Scroll** Force the cursor to stop or wrap around when it reaches the top or bottom of a list in the display.
- Animation** Animation causes your menus to move smoothly, as you scroll up and down.

- Language** Set the language for phone menus:
English or French Canadian – menus and editing
- Contrast** Adjust the contrast setting for your display.
- DTMF** Your phone can send a number to the network as
dual tone multi-frequency (DTMF) tones. DTMF
tones are used to communicate with automated
systems that require you to enter a number such as
a code, password, or credit card number. Use this
option to set DTMF tones to be long, short, or off.
- Master Reset** Reset all options back to their original factory
settings except for the unlock code, security code,
and lifetime timer.
- Master Clear** Reset all options back to their original factory
settings except for the unlock code, security code,
and lifetime timer, and clear all user settings and
entries.

Note: This option erases all user-entered information stored in your phone's memory, including phonebook and datebook entries. Once you erase the information, it cannot be recovered.

Network

-  > Settings
- > Other Settings
- > Network



View and adjust your phone's network settings.

Car Settings



- > Settings
- > Other Settings
- > Car Settings



You can set two options of **Car Settings**:

Auto Answer You can set the phone to automatically answer calls after two rings.

Note: The use of wireless devices and their accessories may be prohibited or restricted in certain areas. Always obey the laws and regulations on the use of these products.







Recent Calls

Viewing Received Calls or Dialed Calls

Your phone keeps a list of the calls you recently received and dialed (up to the last 10 calls), even if the calls did not connect. The lists are sorted from newest to oldest entries. The oldest entries are deleted as new ones are added.

Shortcut: Press  to go directly to the dialed calls list from the idle display.

Find the Feature  > Recent Calls

Press	To
1 	Scroll to Received Calls or Dialed Calls
2 SELECT ()	Select the list
3 	Scroll to an entry Note: The symbol  means the call is connected.
4 	Call the entry's number
or	View entry details
VIEW ()	
or	
	Open the Last Calls Menu to perform other procedures as described in the following list



The Last Calls Menu can include the following options:

Option	Description
Delete	Delete the entry.
Delete All	Delete all entries in the list.
Send Message	Open a new text message with the number in the To field.
Add Digits	Add digits after the number.
Attach Number	Attach a number from the phonebook or recent call lists, after the highlighted number.

Last Number Entered

Your phone temporarily stores in memory the last string of digits that you entered using the keyboard. This number may be a dialed number, or an entered number that was not dialed. To retrieve the number stored in the notepad.

Find the feature  > Recent Calls
> Notepad

Press	To
	Call the number
or	
	Open the Dialing Menu to attach a number or insert a special character
or	
STORE ()	Create a phonebook entry with the number in the No. field.

Viewing and Resetting Call Timers

Network connection time is the elapsed time from the moment you connect to your service provider's network to the moment you end the call by pressing . This time includes busy signals and ringing.

The amount of network connection time you track on your resettable timer may not equal the amount of time for which you are billed by your service provider.

For billing information, please contact your service provider directly.



You can view the following network connection times:



Timer	Description
Last Call	Approximate time spent on last dialed or received call. You cannot reset this timer.
Dialed Calls	Approximate time spent on dialed calls since the last time you reset this timer.
Received Calls	Approximate time spent on received calls since the last time you reset this timer.
All Calls	Approximate time spent on dialed and received calls since the last time you reset this timer.
Lifetime	Approximate time spent on all calls on this phone. You cannot reset this timer.

To view a call timer:

Find the feature



> Recent Calls
> Call Times



Press	To
1 	Scroll to the timer you want
2 SELECT ()	View the recorded time

To reset the call timer:

Press	To
1 RESET ()	Reset the time (if available)
2 YES ()	Confirm the reset

Phonebook

You can store a list of names and phone numbers or email addresses in your phone's electronic phonebook. You have 500 memory cells. You can store up to 5 numbers under each name.

To see the names in your phonebook, press  > **Phonebook** from the idle display. Scroll to a name and press **VIEW** () to view details of the phonebook entry as shown below.

Viewing Entry Details

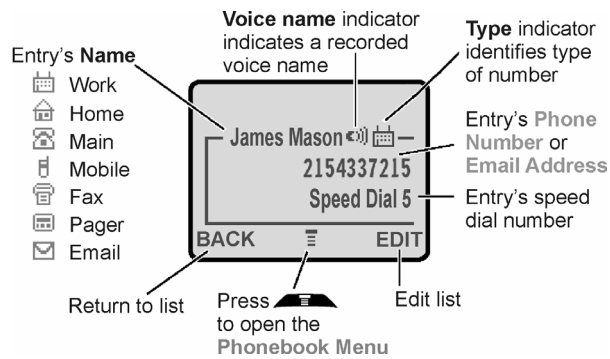

Note: When you set a distinctive ringer alert for an entry, the **Ringer ID** setting appears below the speed dial number.















Storing a Phonebook Entry



A phone number or email address is required for a phonebook entry. All other information is optional.

Shortcut: Enter a phone number in the idle display, then press **STORE** () to create a phonebook entry with the number in the **No.** field. Go directly to step 3 to continue.

Entering data

Find the Feature  > Phonebook
> New entry

Press	To
1 	Scroll to Phone Number or Email Address
2 SELECT (	Select the entry type
3 CHANGE (	Select Name
4 keypad keys	Enter a name for the entry
5 OK (	Store the name
6 CHANGE (	Select No. or Email
7 keypad keys	Enter the phone number or email address (to a maximum of 32 characters) Tip: You can store a PIN code with the phone number (split number). See page 64.
8 OK (	Store the phone number or email address
9 CHANGE (	Select Type Note: This option is not available for email entries.
10 	Scroll to the number type
11 SELECT (	Select the number type
12 RECORD (	A voice name for the entry, if desired or Go to step 13 if you do not want a voice name record
13 	Scroll to Speed No. . The next available speed dial number is assigned to a new phonebook entry.
14 CHANGE (	Select Speed No. if you want to change it
15 keypad keys	Enter a different speed dial number, if desired
16 OK (	Store the speed dial number
17 CHANGE (	Select Ringer ID if you want to assign a

Press	To
	distinctive ringer alert for the phone number. Your phone uses the alert to notify you when you receive a call from this phone number. See page 84.
18 	Scroll to the alert you want
19 SELECT 	Store the ringer ID alert
20 SELECT 	Select MORE if you want to create another entry under the same Name You must use a different Type identifier for each number.



Complete Phonebook Entry

When you are finished entering information for a phonebook entry:

Press	To
DONE 	Store the entry

Storing a Split Number

You can store a PIN code with the phone number for calls that require additional digits (for example, to make a calling card call, or to retrieve voicemail or answering machine messages). Insert one or more of the following characters in the dialing sequence to ensure that the number dials and connects properly:







Press	To
1  > Insert Pause	Insert a p (pause) character Your phone dials the preceding digits, waits for the call to connect, then sends the remaining digit(s).
2  > Insert Wait	Insert a w (wait) character Your phone dials the preceding digits, waits for the call to connect, then prompts you for confirmation before it sends the remaining digit(s).
3  > Insert 'n'	Insert an n (number) character Your phone prompts you for a number before dialing the call. The number you enter is inserted into the dialing sequence in place of the n character

Note: You can store a maximum of 32 digits per number. Each character counts as one digit.

Recording a Voice Name For a Phonebook Entry

You can record a voice name for a new or existing phonebook entry. A voice name lets you call the phonebook entry using voice dial. You may store up to 20 voice names. See page 98.

Find the Feature  > Phonebook



Do This	To
1 Press 	Scroll to the entry
2 Press VIEW ()	View entry details
3 Press EDIT ()	Edit the entry
4 Press 	Scroll to Voice Name
5 Press RECORD ()	Begin recording
6 Press and release the voice activation key and say the entry's name (in two seconds)	Record the voice name
7 Press and release the voice activation key and repeat the name	Confirm the voice name
8 Press DONE ()	Store the voice name

Dialing a Phonebook Entry

Use one of the following procedures to call a number (or send a text message to an email address) stored in your phonebook.

Phonebook List

Find the Feature  > Phonebook

Press	To
1 keypad key letter	Jump to entries that begin with that letter (optional)
2 	Scroll to the entry
3 	Make the call



Voice Dial

Do This	To
Press and release the voice activation key and say the entry's name (in two seconds)	Make the call

To speed dial a phonebook entry, see page 31, and to call an entry with one-touch dial, see page 31.

Editing a Phonebook Entry





Find the Feature  > Phonebook

Press	To
1 	Scroll to the entry
2 VIEW ()	View entry details
3 EDIT ()	Edit the entry

Edit the entry as described on previous pages.

Deleting a Phonebook Entry

Find the Feature  > Phonebook

Press	To
1 	Scroll to the entry
2 	Open the Phonebook Menu
3 	Scroll to Delete
4 SELECT ()	Select Delete
5 YES ()	Confirm the deletion







Note: You cannot restore deleted entries.

Sorting the Phonebook List

You can sort your phonebook list by speed dial number (memory cell), name, email address, or voice name.

Note: The voice name sort is identical to the name sort, except that entries with voice nametags appear first.

Find the Feature  > Phonebook

Press	To
1 	Open the Phonebook Menu
2 	Scroll to Setup
3 SELECT ()	Select Setup
4 	Scroll to Sort by
5 CHANGE ()	Select Sort by
6 	Scroll to Name, Speed No., Voice Name, or Email
7 SELECT ()	Select the sort order





Icon Viewer



Your phone contains icons and animations that you can use as a screen saver.

Note :Your phone may include predefined icons. These icons are identified by a  (predefined object) indicator. You cannot rename, delete, or view details about predefined icons.

Find the Feature  > Icon Viewer

Press	To
1 	Scroll to the icon
2 SELECT ()	View the icon
3	View the previous/next icon
or DETAILS ()	View icon information
or 	Open the Icon Viewer menu to perform other procedures as described in the following list

The **Icon Viewer** menu can include the following options:

Option	Description
Details	View icon information.
Set as Screen Saver	Set the icon as your phone's screen saver image.
Rename	Rename the icon.
Delete	Delete the icon.

To adjust your phone's screen saver images, see page 105.

Datebook

The datebook is a calendar that lets you schedule and organize events such as appointments and meetings. You can set the datebook to send a reminder alarm for specific events.

Note: You must set the correct time and date on your phone to use the datebook.

To schedule or review datebook events:

Find the Feature  > Datebook

Week View

The datebook displays a calendar for the week by default. Lines or filled boxes indicate scheduled events.

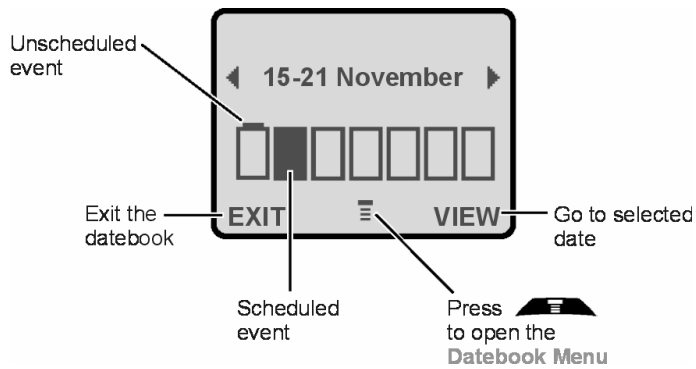

Day View

Select a day and press **VIEW** () to see the day's events.

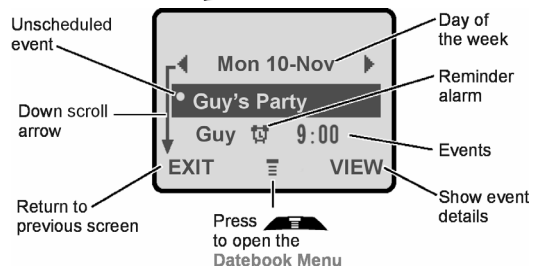

Event View

Select an event and press **VIEW** () to see event details.

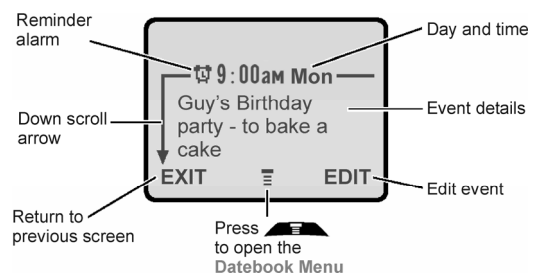





Adding a Datebook Event

A title is required for a datebook event. All other information is optional.









Note: You must create an event to use the reminder alarm.

Find the Feature  > Datebook > day
> New Event

Press	To
1 CHANGE ()	Select Title
2 keypad keys	Enter a title for the event
3 OK ()	Store the event title
4 	Scroll to other fields and enter information as necessary. You can set start time, duration, date, repeat interval, and reminder alarm.
5 DONE ()	Store the event













Changing Event Information

Find the Feature  > Datebook

Press	To
1  or 	Scroll to the day
2 VIEW ()	Display the day view
3 	Scroll to the event
4 VIEW ()	Display the event view
5 EDIT ()	Edit the event
6 	Scroll to the information you want to change
7 CHANGE ()	Edit the information
8 keypad keys	Enter new information
9 DONE ()	Store the information









Copying an Event

Find the Feature  > Datebook

Press	To
1  or 	Scroll to the day
2 VIEW ()	Display the day view
3 	Scroll to the event
4 	Open the Datebook Menu
5 	Scroll to Copy
6 SELECT ()	Copy the event
7 YES ()	Confirm the copy Your phone assumes you want to change the date, and displays the Date field.
8 keypad keys	Enter date information
9 ()	Move to month, day, and year
10 DONE ()	Save the copy of the event
11 	Scroll to and edit event information, if necessary
12 DONE ()	Store the information

Deleting an Event

Find the Feature  > Datebook

Press	To
1  or 	Scroll to the day
2 VIEW ()	Display the day view
3 	Scroll to the event
4 	Open the Datebook Menu
5 	Scroll to Delete
6 SELECT ()	Select Delete
7 YES ()	Confirm the deletion

Messages – Voicemail



You can listen to your voicemail messages by calling your network voicemail phone number (voicemail service). Voicemail messages are stored on the network—not on your phone.

Storing Your Voicemail Number

Storing your voicemail number on your phone makes it easy for you to listen to new voicemail messages. In many cases, your service provider has already done this for you.

Find the Feature  > Messages
 > Voicemail
 > Voicemail setup

Press	To
Select ()	

Press	To
1 keypad keys	Enter your voicemail number. Tip: You can store your PIN code with the voicemail number. See page 109.
2 OK ()	Store the number

Your service provider additionally may store your voicemail number as phonebook entry number 1, so you can use one-touch dial to listen to your voicemail messages. If necessary, see page 62 to store your voicemail number for one-touch dial access.

Receiving a Voicemail Message

When you receive a voicemail message, your phone displays the  (voice message waiting) indicator and a **New Voicemail** notification

Press	To
CALL ()	Listen to your message

If reminders are turned on, your phone sends a reminder at regular intervals until you close the new message notification, listen to the message, or turn off your phone.

Listening to a Voicemail Message

Find the Feature  > Messages > Voicemail

The phone calls your voicemail number. If no voicemail number is stored, your phone prompts you to store one.

Shortcut :If your voicemail number is also stored as phonebook entry number 1, you can press and hold  to listen to your voicemail message.

Canceling the “Voice Message” indicator

To delete the  (Voice message waiting) indicator:

Find the Feature  > Messages
> Voicemail
> Cleanup Now

Messages – Text







Text messages are brief messages that you can send and receive. Quick notes are pre-written text messages that you can incorporate into a message and send quickly.

The number of messages the inbox can hold depends on the length of the messages, and the number of other messages and drafts stored on your phone. Your device is set up for 50 incoming messages and 20 outgoing messages.

Setting up the Text Message Inbox

Note: In many cases, your service provider has already set up the text message inbox for you.

Find the Feature  > Messages
 > Inbox
 > Setup

Press	To
1 CHANGE ()	Change the Cleanup setting
2 	Scroll to the number of days you want to keep messages in the inbox, or the number of messages you want to keep
3 SELECT ()	Select the cleanup setting
4 DONE ()	Save the inbox settings

Receiving a Text Message

When you receive a text message, your phone displays the  (message waiting) indicator and a **New Inbox Message** notification, and gives an alert.









Press	To
1 READ ()	Open the message

If reminders are turned on, your phone sends reminders at regular intervals until you close the new message notification, read the message, or turn off your phone. When your phone displays **Memory is Full!**, you must delete some existing messages to receive new messages.

Reading, Locking, or Deleting a Text Message

Messages in the text message inbox are sorted from newest to oldest. The oldest messages are deleted automatically as specified by the inbox cleanup setting (see page 77). If you want to save a message, you should lock it to prevent it from being deleted during cleanup.

Find the Feature  > Messages > Inbox

Press	To
1 	Scroll to the message. The following indicators show message status:  = Unread  = Unread and urgent  = Read  = Read and locked
2 SELECT ()	Open the message
3 BACK () 	Close the message Open the Inbox Menu to perform other procedures as described in the following list

The Inbox Menu includes the following options:











Option	Description
Call Back	Call the number in the message header or embedded in the message.
Reply	Open a new text message, with the sender's Reply To number or email address in the To field.
Forward	Open a copy of the text message, with an empty To field.
Lock/Unlock	Lock or unlock the message.
Store	
Delete	Delete the message.
Delete All	Delete all inbox messages.
Create Message	Open a new text message.
Setup	Open the text message inbox setup menu.
Go To	Launch the micro-browser and go to a web address (URL) embedded in the message.









Sending a Text Message

You can send a text message to one or more recipients (up to 10 recipients). You can manually enter each recipient's phone number or email address, or select numbers/addresses from the phonebook or recent call lists.

Note: When you manually enter numbers and/or email addresses, you must insert a space between each entry. Press  one time, wait for the space to appear, and then enter the next number or email address.

Find the Feature  > Messages
> New Message



Press	To
1 CHANGE ()	Select To
2 keypad keys	Enter one or more phone numbers and/or email addresses Tip :Press  , to insert a space between each number/address that you enter manually.
or	
BROWSE ()	Select numbers/addresses from the phonebook or recent call lists as follows: Highlight one of the following options: Phonebook, Received Calls, or Dialed Calls
A 	
B SELECT ()	Select the list
C 	Highlight a number/address
D ADD ()	Add the number/address to the list of message recipients
E DONE ()	Return to the message editor when you are finished
3 OK ()	Store the numbers/addresses
4 CHANGE ()	Select Msg option
5 keypad keys	Enter the message Note :Message length is limited to 126 characters. A display counter displays the number of characters left.

Press	To
<p>or</p> <p>INSERT ()</p>	<p>Select and insert a quick note message (see page 82)</p> <hr/> <p>Enter the message</p> <p>Note: Message length is limited. A display counter cycles between the number of pages you have written (number preceded by a *), and the number of characters left on the current page. Network charges are based on the number of pages sent.</p>
<p>or</p> <p>BROWSE ()</p>	<p>Select and insert a quick note message (see page 82)</p>
6 OK ()	Store the message
7 CHANGE ()	Select Call
8 keypad keys	Enter a number for the recipient to call back
9 OK ()	Store the number
10 DONE ()	Finish the message. Your phone displays the total number of pages in the message.
11 YES ()	Send the message
<p>or</p> <p>No ()</p>	Cancel the message or save it in the drafts folder.

Sending a Quick Note Text Message

Quick notes are pre-written text messages that you can incorporate into a message and send quickly (for example, I'm on my way). You can also create new quick notes.

Find the Feature  > Messages
> Quick Notes

Press	To
1 	Scroll to the quick note
2 READ ()	Read the quick note
or	
	Open the Quick Note Menu to perform other procedures as described in the following list.

The **Quick Note Menu** can include the following options:

Option	Description
New	Create a new quick note.
Edit	Edit the quick note.
Delete	Delete the quick note.
Send	Open a new message with the quick note in the Msg field.



Viewing the Status of Sent Text Messages



Text messages that you send are stored in the Outbox.

Find the Feature  > Messages > Outbox

Messages in the Outbox are sorted from newest to oldest.
The following indicators show message status:

 = Sending in progress
 = Sending failed

 = Sent

Ring Styles





Your phone rings to notify you of an incoming call or other event.

Each ring style contains settings for specific event alerts, ringer type (ringer ID), and ringer and keypad volume.

Customizing a Ring Style

Change Style Settings

You can change the alerts that notify you of the following events: incoming calls, text messages, voicemail messages, data calls, fax calls, alarms, and reminders. Any changes you make are saved to the current ring style. You have 36 different ring options.

Find the Feature		> Settings > Ring Styles > Loud Detail
Press		To
1		Scroll to the event
2	CHANGE ()	Select the event
3		Scroll to the alert you want
4	SELECT ()	Select the alert



Activate and Deactivate Ringer IDs

When ringer IDs are turned on, your phone uses distinctive ringer alerts to notify you of incoming calls or messages from specific entries stored in your phonebook.

Find the Feature		> Settings > Ring Styles > Loud Detail
-------------------------	---	--

Set Ringer or Keypad Volume

Find the Feature  > Settings
> Ring Styles
> Loud Detail







Press	To
1 	Scroll to Ring Volume or Key Volume
2  or 	Scroll to the desired volume

Creating Alert Tones

You can create and store custom alert tones on your phone. The tones appear in the list of available alerts.







Create a Tone

Find the Feature  > Settings
> Ring Styles
> My Tones

Press	To
1 	Scroll to [New Tone]
2 SELECT ()	Select [New Tone]
3 CHANGE ()	Select Notes
4 keypad keys	Enter notes (see following section)
5 OK ()	Store the notes
6 CHANGE ()	Select Name
7 keypad keys	Enter a name for the tone
8 OK ()	Store the name
9 DONE ()	Store the tone

Entering Notes

Use the keypad keys to enter each note. Press a key multiple times to cycle through its notes or options (pitch, octave, or length). The default setting for a new tone is a quarter note in octave two.

Key	Display	Description
1 	1	Set octave one
	2	Set octave two
	3	Set octave three
2 	A	Note A
	B	Note B
	C	Note C
3 	D	Note D
	E	Note E
	F	Note F
4 	G	Note G
	R	Rest
7 	#	Sharp
	b	Flat
0 	q	Quarter note or rest
	h	Half note or rest
	w	Whole note or rest

Enter a note as follows:

Task	Action
Change the octave	Set the new octave (1, 2 or 3) <i>before</i> selecting the note. The octave applies to all following notes until you change it again.
Select the note (required)	Press a keypad key.
Change a note to a sharp or flat	Enter a sharp or flat (# or b) <i>after</i> selecting the note. Some sharps and flats are played as standard notes. For example, B# is the same as C. Press to scroll to valid notes when entering a new note.
Change a note's length	Set the new length (q, h, or w) <i>after</i> selecting the note. The length applies to all following notes until you change it again.
Add a rest	Enter one or more rests (R characters) as needed in the tone sequence. Set the length of the rest by entering a q, h, or w character <i>after</i> the rest, just as you would for a note.
Listen to a new tone as you compose it	Press  to enter the Compose Menu , and select Play All to play the notes you have entered.

Example

Press the following keys to play this sequence of notes and rests in octave three:
 C (quarter note), E flat (quarter note), half rest, and G (whole note):

Press	To	Display
1	Set octave three	3
2	Enter a quarter note C	C
3	Enter a quarter note E flat	Eb
4	Enter a half rest	Rh
5	Enter a whole note G	Gw

Play a Tone

Find the Feature









- > Settings
- > Ring Styles
- > My Tones

Press	To
1	Scroll to the tone
2	Open the Tone Menu
3	Scroll to Play
4 SELECT ()	Select Play
5 PLAY ()	Play the tone again
or	
CANCEL ()	Return to My Tones list

Edit a Tone

You cannot edit the predefined alert tones included with your phone. To edit a custom alert tone:





Find the Feature  > Settings
> Ring Styles
> My Tones

Press	To
1 	Scroll to the tone
2 EDIT ()	Open the tone details
3 	Scroll to the item you want to edit (Name or Notes)
4 CHANGE ()	Select the item
5 keypad keys	Enter new text or notes
6 OK ()	Store the new text or notes
7 DONE ()	Save your changes

Delete a Tone

You cannot delete the predefined alert tones included with your phone. To delete a custom alert tone:



Find the Feature  > Settings
> Ring Styles
> My Tones

Press	To
1 	Scroll to the tone
2 	Open the Tone Menu
3 	Scroll to Delete
4 SELECT ()	Select Delete
5 YES ()	Confirm the deletion

Setting Reminders

A reminder is an alert that rings or lights up at regular intervals to notify you about a voicemail or text message that you have received.

Find the Feature  > Settings
> Ring Styles
> Loud Detail
> Reminders





Press	To
1 	Scroll to set the reminder alert type, or Off to turn off all reminders
2 SELECT ()	Select the reminder alert

Shortcuts

Your phone includes several standard shortcuts. You can create additional shortcuts to frequently used menu items.





Standard Shortcuts





The following shortcuts are pre-programmed in your phone. You cannot edit or delete these shortcuts.

Do This	To
1 Press  , then press  (within two seconds)	Zoom in/out on your phone display
2 Press 	See your phone number
3 Press 	Go to the dialed calls list
4 Press 	Exit the menu system

Creating a Shortcut

You can create a keypad shortcut (9 in all) plus an optional voice shortcut (5 in all) to a menu item. When creation of a shortcut through a certain item is invalid, a message "Shortcut for this item is invalid" will appear. A voice shortcut takes you directly to the menu item when you say the shortcut name.

Do This	To
1 Press 	Enter the menu system
2 Press 	Scroll to the menu item
3 Press and hold 	Open the shortcut editor
4 Press YES 	View shortcut options

Do This	To
5 Press CHANGE () or Press DONE () or Press 	Change the keypad shortcut number Select the default keypad shortcut number Scroll to Voice to assign a voice shortcut
6 Press RECORD ()	Begin recording
7 Press and release the voice activation key and say the shortcut's name (in two seconds)	Record the shortcut name
8 Press and release the voice activation key and repeat the name	Confirm the shortcut name
9 Press DONE ()	Store the shortcut name

Using Shortcuts

Use a Keypad Shortcut

Press	To
1 	Open the main menu
2 a number key	Go to the menu item with that shortcut number

Select a Shortcut from the List

Find the Feature  > **Shortcuts**
> *shortcut name*

Use a Voice Shortcut

Do This	To
1 Press 	Open the main menu
2 Press and release the voice activation key and say the shortcut's name (in two seconds)	Go to the menu item with that shortcut name

VoiceNotes™

You can use the VoiceNote™ feature to record personal messages and phone calls on your phone. You have 2 minutes in all to record VoiceNotes™.

Recording a VoiceNote™

Use this procedure to record a VoiceNote™ from the idle display, or to record a phone call in progress (the voice of the other party). Your phone plays an alert tone to notify the other party that the call is being recorded.

Note: Recording phone calls is subject to varying laws in different states regarding privacy and recording of conversations.

Do This	Result
1 Press and hold the voice activation key (at least 2 seconds).	The phone sounds an alert tone and begins recording.
2 Speak your VoiceNote™.	The phone records the VoiceNote™.
3 Press the voice activation key to stop the recording.	The phone displays the VoiceNote™ number and total recording time.

Viewing the VoiceNotes™ List

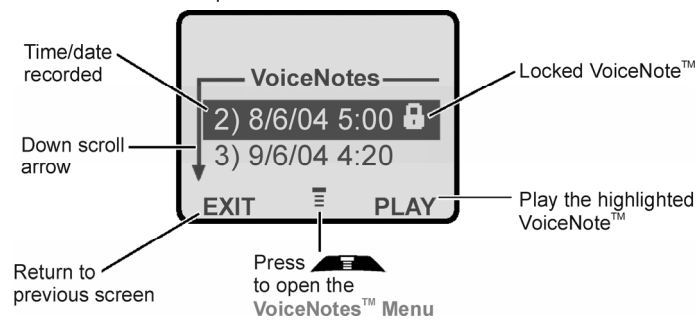

Find the Feature  > VoiceNotes™

Note: VoiceNotes are equivalent to Voice Record



Playing a VoiceNote™

Find the Feature  > VoiceNotes™

Press	To
1 	Scroll to the VoiceNote™
2 PLAY ()	Play the VoiceNote™

When you connect an optional Motorola Original™ headset to your phone, playback is routed automatically to the headset.

Tip: You can play a VoiceNote™ while taking a call. It will not be transmitted to the other party.

Recording any VoiceNote™ enables access to the VoiceNotes™ list.

Playback Screen

The playback screen is displayed as the VoiceNote™ plays.

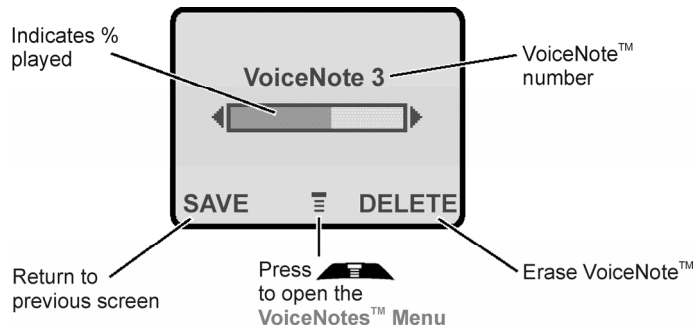





VoiceNote™ Controls





Locking a VoiceNote™

Lock a VoiceNote™ to prevent it from being deleted.

Find the Feature  > VoiceNotes™

Press	To
1 	Scroll to the VoiceNote™
2 	Open the VoiceNotes™ Menu
3 	Scroll to Lock
4 SELECT 	Lock the VoiceNote™







To lock a VoiceNote™ during playback:

Press	To
1 	Open the VoiceNotes™ Menu
2 	Scroll to Lock
3 SELECT 	Lock the VoiceNote™

Playback stops when you lock a VoiceNote™.
Press any number key to resume playback.

Deleting a VoiceNote™

Find the Feature  > VoiceNotes™

Press	To
1 	Scroll to the VoiceNote™
2 	Open the VoiceNotes™ Menu
3 	Scroll to Delete or Delete All
4 SELECT ()	Select the highlighted option
5 YES ()	Confirm the deletion
or	
NO ()	Cancel deletion

Comments:

- You cannot delete a locked VoiceNote™.
- You cannot recover a deleted VoiceNote™.

Voice Activation

Your M800 Bag Phone is equipped with advanced features that enable you to activate the phone audibly by dialing names, digits, and direct access to menus.

Find the Feature  > Settings
> Voice Activation

Language  > Settings
> Voice Activation
> Language

Enables the selection of a language to dial digits.

Voice Comments  > Settings
> Voice Activation
> Voice Comments

Enables the playback of voice instructions while using the features of voice activation, for example: "Say a name", "Say a number".

Training  > Settings
> Voice Activation
> Training

Enables maximum compatibility between the user's accent and the voice operating system for dialing digits. Follow the system instructions. The character that you must pronounce will appear on the display. Say the character after the instruction. Repeat the characters, as required, in accordance with the appearance on the display.

Dialing Names

Your phone supports voice dial through the saying of names previously entered into the device's memory. It is possible to store up to 20 names in the voice dial memory.

To operate the phone using voice dial, the name must be recorded (see page 62) with the user's voice only.

Operation of this feature is very simple and was planned to be so in advance.

Do this	Result
<p>1 Press and hold the voice activation key.</p> <p>Voice activation key</p> 	<p>The phone emits a voice message "Say name"</p>
<p>2 Say the name that you wish to call out aloud.</p>	<p>The name is displayed on the display and the number is dialed automatically.</p>

Note: Incoming calls may be answered by pressing the voice activation key. Pressing the voice activation key again will stop the process and return the phone to standby.

Voice-Activated Speed Dialing

Each entry in your phonebook is assigned a unique speed dial number that identifies where the entry is stored in phone memory or on the SIM card. You can initiate phone calls by speaking this number to the M800, which will then dial the call.

Note: Voice-activated speed dialing uses M800 Bag Phone phonebook memory locations 1 through 99.

Do this	Result
<p>1 Press the voice activation key twice</p>	<p>The phone plays a voice message: "Say number".</p>
<p>2 Speak the digits of the phonebook entry that you want to call:</p>	<p>For example:</p> <ul style="list-style-type: none"> • To dial phonebook entry 99, say "nine, nine" and then say pound. • To dial phonebook entry 7, say "seven" and then say "pound".

Dialing Digits

The phone supports dialing telephone numbers (including the * asterisk character) with user's voice. This feature does not require recording the numbers in advance (as dialing names does).

Do this	Result
1 Press the voice activation key rhythmically twice	The phone beeps once and plays a voice message "Say number"
2 Say aloud the telephone number that you wish to dial (each digit separately)	The number is displayed on the display panel, and the dial process is performed automatically

Note: incoming calls may be answered by pressing the voice activation key. Pressing the voice activation key again will stop the process and return the phone to standby.

Voice Shortcuts to Features

This feature enables the user to access the menus directly. Up to 5 shortcuts may be stored in memory. Activation of this feature requires prior training of the system using a recording of the user's voice. See page 90.

Do this	Result
1 Press once of the "Menu" key and immediately once on the voice activation key	The phone beeps once and plays a voice message "Say shortcut"
2 Say aloud the shortcut that you wish to use	The menu associated with the shortcut appears



Micro-Browser





The Micro-Browser lets you access Web pages and Web-based applications on your phone. Contact your service provider to set up access, if necessary.

Starting a Micro-Browser Session







Find the Feature  > Browser

Press	To
1 	Scroll to a bookmark, service, or an application
2 SELECT ()	Select the item

Shortcut: press and hold the upper 2-way navigation key will launch the browser automatically. In addition, if you open a text message that contains a web address (URL) you can press  > Go To URL to launch the browser and go directly to the internet address. You can press and hold  to go directly to the home page.

If you are unable to establish an internet connection with the micro-browser, contact your service provider.

Using Web Pages

Press	To
1 	Scroll down the text, or highlight a selectable item
2 SELECT ()	Select the highlighted item
3 	Dial the telephone number highlighted in the micro-browser
4 Keypad keys, then press OK ()	Enter information. Tip: Press DELETE () to delete one letter at a time, in the event of a typing error
5 BACK ()	Go back to the previous page
6 	Open the Browser Menu



Calculator

You can use your phone as a calculator and currency converter.

Note: The last result displayed remains in the memory even after you exit the feature or switch off the device. To reset the result, press C, CE.

Calculating Actions

Find the feature  > Calculator

Press	To
1 number keys	Enter a number
2  or 	Highlight a calculator function
3 SELECT 	Perform the action

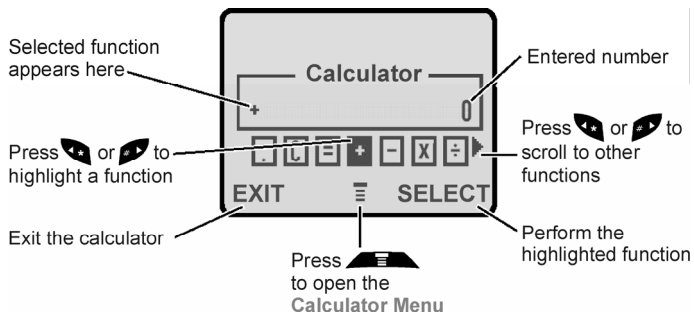

The calculator can perform the following functions:

Function	Description
.	Insert a decimal point
C	Clear the calculation
=	Calculate the result
+	Add
-	Subtract
x	Multiply





Function	Description
÷	Divide
%	Divide the displayed value by 100
\$	Calculate the exchange rate
+/-	Change the entry's sign (positive/negative)
MR	Replace the displayed value with the value stored in memory
MS	Store the value in memory (overwrites current stored value)
MC	Clear the value stored in memory

Converting Currency

The currency converter works just like the calculator, but uses the \$ (currency) function.

Note: Enables precision of 6 digits after the decimal point.

Find the Feature  > Calculator
 > Exchange Rate





Press	To
1 number keys	Enter the exchange rate
2 OK ()	Store the exchange rate
3 number keys	Enter the amount to convert (amount to multiply by the exchange rate)
4  or 	Highlight the \$ function
5 SELECT ()	Perform the conversion

Adjusting Your Settings

Reordering Menu Items

You can reorder the items in your phone's main menu:





Find the Feature  > Settings
> Other Settings
> Personalise
> Main Menu

Press	To
1 	Scroll to a menu item
2 GRAB ()	Grab the menu item
3 	Move the item to a new location in the menu
4 INSERT ()	Insert the menu item

Customizing a Soft Key Function

You can change the soft key features ( and ) to access different menu features from standby.

Find the Feature  > Settings
> Other Settings
> Personalise
> Keys









Press	To
1 	Scroll to Left or Right
2 CHANGE ()	Select the key
3 	Scroll to the new key feature
4 CHANGE ()	Confirm the new feature

Screen Saver

You can set a icon or an animation as a screen saver image in your phone's idle display. The image is displayed when no activity is detected for a specified time.

The screen saver image is shrunk to fill the display, if necessary. An animation repeats for one minute, and then the first frame of the animation is displayed.

Find the Feature  > Settings
> Other Settings
> Personalise
> Screen saver

Press	To
1 	Scroll to Picture
2 CHANGE ()	Open the Icon Viewer
3 	Scroll up or down to a picture/animation Scroll to (None) to turn off the screen saver image.
4 SELECT ()	Select the image
5 	Scroll to Delay
6 CHANGE ()	Set the delay interval
7 	Scroll to the inactivity interval that triggers the screen saver
8 SELECT ()	Confirm the delay setting
9 DONE ()	Save screen saver settings

Data and Fax Calls



An optional Motorola Original™ data kit (which includes a cable connector and a CD) lets you transfer data between your phone and a portable computer with a MICROSOFT WINDOWS 2000 or XP operating system.

With Motorola data kit you will be able to:

- Use the phone device as a modem, to connect to the internet.
- Use the phone to send and receive data and fax calls to your portable computer.
- Synchronize your phonebook and your contacts

Install the Software

To transfer data between your phone and computer, you must install the software included with the Motorola Original data kit. See the data kit's user guide for more information.

Attach the Cable

Use a Motorola Original serial cable or Motorola Original MINI USB cable to connect your phone to the external device.

Mini USB Cable

Do this

- 1 Connect the mini USB cable to the USB com port at the front of the M800 Bag Phone and to the USB connector at the portable computer.

Sending a Data or Fax Call

Use this procedure to send data or a fax from a connected device. Connect your phone to the device, as described in the last pages, and afterwards do the following:

Do this	To
1 Check the phone	Make sure that the phone is connected and powered on
2 Open the application on your computer	Place the call through the application (such as dial-up-networking or fax). Note: You cannot dial data or fax numbers through your phone's keypad. You must dial them through your computer.
3 End the call from the connected device	Close the call and connection when the transfer is complete



Receiving a Data or Fax Call

Use this procedure to transfer data or a fax to your portable computer. Connect your phone to the device as described on page 108.

Find the Feature



> Settings
> Connection
> Incoming Call

Do this	To
1 Press CHANGE ()	Select Next Call
2 Press 	Scroll to Data In Only or Fax In Only
3 Press SELECT ()	Set the call format
4 Connect your phone to the device	Enable the data or fax transfer

Note: You cannot answer incoming voice calls when your phone is in data or fax mode. Any voice calls you receive are treated as unanswered calls. To return a voice call, reset your phone to voice mode as described on this page.

Transfer Data or Fax

Your phone notifies you when the data or fax call arrives, and transfers the call to the connected device. Use the application running on the device to answer the call.

End the Data/Fax Connection

When the data or fax transfer is completed, end the call from the connected device to close the connection.

Reset Normal Voice Operation

After making a data or fax call, you must reset your phone to resume normal voice operations.



Your phone also reverts to normal voice operation when you turn it off and then turn it back on.

Security

Assigning a New Code or Password

Your phone's unlock code is originally set to 1234, and the security code is originally set to 000000. Changing them is recommended in order to avoid access by other users to your personal information. The unlock code must contain 4 digits, and the security code must contain 6 digits.





Notes:

- Your service provider may retain your phone's security code for customer service purposes. In this case, you will not be able to use phone features that require you to enter the security code.
- If the unlock code is the only code that you can change, the **New Passwords** menu will not be available. In this case, change the unlock code by selecting the following:

Find the Feature  > Settings > Security
> Phone Lock > Unlock Code



To change a code or password:

Find the Feature  > Settings > Security
> New Passwords

Press	To
1 	Scroll to the code or password
2 CHANGE ()	Select the code or password
3 keypad keys	Enter your old code
4 OK ()	Confirm your old code
5 keypad keys	Enter the new code
6 OK ()	Assign the new code
7 keypad keys	Re-enter the new code
8 OK ()	Confirm the new code

If You Forget a Code or Password

If you forget your security code, contact your service provider. If you forget your unlock code, try the last four digits of your phone number. If that does not work, do the following at the **Enter Unlock Code** prompt:

Press	To
1 	Go to the unlock code bypass display
2 keypad keys	Enter your security code
3 OK ()	Confirm your security code

Locking and Unlocking Your Phone

You can lock your phone manually or set the phone to lock automatically whenever you turn it off.

To use a locked phone, you must enter the unlock code. A locked phone still rings or alerts for incoming calls or messages, *but you must unlock it to answer.*

You can make emergency calls on your phone even when it is locked. For more information, see page 29.

Lock Your Phone Manually

Find the Feature  > Settings > Security
> Phone Lock > Lock Now

Press	To
1 keypad keys	Enter your unlock code
2 OK ()	Lock the phone

Set Your Phone to Lock Automatically

You can set your phone to lock every time you turn it off.

Find the Feature



> Settings > Security
> Phone Lock > Automatic Lock > On

Press	To
1 keypad keys	Enter your unlock code
2 OK ()	Activate automatic lock





Unlock Your Phone

At the Enter Unlock Code prompt:

Press	To
1 keypad keys	Enter your unlock code
2 OK ()	Unlock your phone





Troubleshooting

Check these questions first if you have problems with your phone. If you need additional help, contact the Motorola Customer Call Center.

Problem	Solution
Is your phone set up correctly?	Press   . If you do not see your phone number, contact your service provider.
Does the handset have a signal? Do you see  in the display?	Make sure that your antenna is fully extended. The signal strength indicator should have at least one segment showing  . If it does not, move to an area with a stronger signal to use your phone.
Is the earpiece volume too low?	While on a call, press the upper volume key on the side of your phone.
Is the other party unable to hear you?	Make sure that your antenna is fully extended and that your phone is not muted. Press UNMUTE  to cancel the mute. Also, make sure that your phone's carrying case or a sticker is not blocking its microphone.

The following refer to specific problems:

Problem	Solution
My phone was stolen. To whom should I report this?	Report a stolen phone to the police and to your service provider (the company that sends you your monthly wireless service bill).
I forgot my password.	See page 110.
I pressed the power key, but nothing happened.	Be sure to press and hold  (the power key) until the display appears and you hear an alert. This could take several seconds.
The display says: Enter Unlock Code. How do I unlock my phone?	Enter the factory-preset unlock code (1234), or the last four digits of your phone number. If this fails, call your service provider (the company that sends you your monthly wireless service bill).
My phone asks for an unlock code when I try to open a feature.	The application you want is locked. If you do not know the unlock code, see page 111.
My phone does not ring.	The ringer is set to low. Raise the volume using the VOL UP DOWN keys.
I tried to place a call and heard an alternating high/low tone.	Your call did not reach the wireless system. You may have dialed the number too soon after turning the phone on. Wait until the display says Ready before making a call.
I cannot send/receive calls.	Make sure that your antenna is fully extended and that you have a phone signal (see the "Signal Strength indicator" item in the relevant section). Avoid electrical or radio interference, and obstructions such as bridges, parking garages, or tall buildings.
My phone has poor reception and drops calls.	Make sure that your antenna is fully extended and is not bent or damaged. Also, make sure you have a phone signal (see the "Signal Strength Indicator" in the relevant section). Stay clear of any obstructions such as bridges, parking garages, or tall buildings.
I cannot hear the other party on my phone.	While on a call, press the upper volume key. The display should show the volume increasing. Also, make sure that your phone's earpiece is not blocked.

Problem	Solution
I cannot open my message inbox.	Before you can use text messages, you must set up the message inbox. See the relevant section.
How do I see the calls I sent or received?	To see the most recent calls you dialed or received:  > Recent Calls > Received Calls or Dialed Calls
My phone will not send voicemail commands, passwords, or other codes.	Your phone sends commands and passwords as DTMF tones. You can set your phone's DTMF tones to be Long, Short, or Off. If you have trouble sending numbers, try changing the DTMF setting: 1 From the idle display, press:  > Settings > Other Settings > Initial Setup > DTMF 2 Press  to scroll to Long or Short (some analog networks may not recognize short tones). 3 Press SELECT () to select the desired feature.
My phone's display is too dark.	Use the Contrast feature to change the level of contrast in your display. See the relevant section.
The background lighting is too high/low.	Use the Backlight display feature to change the level of the backlight.
The phone won't turn off.	Make sure that the Power Off Delay is set to zero.
I can not turn the phone off with the POWER OFF key and switching the power switch to OFF.	Press and hold the Voice Activation key and the volume down key for one second.
I am unable to record a VoiceNote™, voice name, or voice shortcut.	Try moving to a quieter location to make your voice recording. Speak directly into the phone in a normal tone of voice.

Problem	Solution
<p>I plugged the data cable into my phone but my phone did not beep. How do I know if the data cable is ready to go?</p>	<p>The beep indicates that you are set up correctly. If you did not hear a beep, make sure that both ends of the data cable are connected - the smaller end to your phone and the larger end to your computer. Also, your computer may have deactivated the port to save power. Try opening an application that uses the port, like a fax or dial-up application, to automatically activate the port.</p>
<p>My phone beeped when I attached the data cable, but my data and fax applications don't work.</p>	<p>You must be in an area with digital coverage. Check your phone's display for the digital signal indicator (D). Some wireless networks may not support data or fax transmission. If you see the digital indicator, but you are roaming on an unfamiliar network, this may be the case. Also, remember that data and fax transmission usually requires a subscription. Call your service provider for more information.</p>
<p>When sending data with the data cable, why does the computer show a connection rate of 19,200 Kbps?</p>	<p>19,200 Kbps is the data transfer rate of the connection between your computer and the phone. The rate of the connection between your phone and the network is displayed on your phone, and will be either 14400 or 9600 Kbps.</p>
<p>I can't end my data call by closing the application on my computer. What can I do?</p>	<p>Try pressing . Or try disconnecting the cable or turning off the phone. If possible, always close the connection through your computer, as these alternative methods may disrupt the application on your computer.</p>
<p>I launched the micro-browser but the display says: Service Not Available.</p>	<p>You may be in an area without service. If you have wireless service, look in the display for the digital signal indicator (D). If you do not see the indicator, you may be in an area that has only analog service or no service at all. If you see the digital signal indicator, you may be connected to a digital network that does not support Internet access.</p>
<p>I launched the micro-browser but the display says: Data Server Unavailable.</p>	<p>Try again in a few minutes. The servers may be temporarily busy.</p>



Safety and General Information

☞ Important

Be sure to read the information that appears here before using your M800 Bag Phone.

The Motorola M800 Bag Phone is a hands-free telephone specially designed to enable you to enjoy its features with minimal distraction while you talk.

Exposure to Signals in the Radio Frequency

Your M800 Bag Phone operates as a radio transmitter and receiver at low capacity. When the device **is operating**, it broadcasts and receives radio frequency (RF) signals.

National and international sources have determined standards and recommendations for protection of the public from exposure to RF electromagnetic energy. Below are a few of them:

- International Commission of Non-Ionizing Radiation Protection (ICNIRP) 1998.
- German Technicians Union (VDE) DIN-0848.
- United States Federal Communication Committee; guidelines for exposure to radio frequencies (1996) FCC.
- National Administration for radiological protection of the British kingdom GS 11, 1988.
- American National Standards Institute (ANSI), IEEE. C95. 1-1992.
- National Council on Radiation Protection and Measurements (NCRP) Report 86.
- Ministry of Health (Canada), Safety Code 6.

Scientists, engineers, and doctors from universities, governmental Health Ministries, and the industry based the recommendations and standards on comprehensive scientific reviews, which reviewed the effect on the human body in order to develop the protective standards. The planning of your telephone complies with these standards under normal conditions of use.

Antenna Care

Use only the original supplied antenna, or an approved replacement. Unauthorized or modified antenna could damage the phone and contravene instructions of local resources.

Note: Ensure that the antenna is at least 20 cm from your body.

Antenna to use

In all configurations, use of the supplied swivel antenna complies with FCC and Industry Canada RF exposure requirements. If an external antenna is used, please refer to the accessory manufacturer for user guidelines.

Electronic Standards

Most modern electronic equipment is protected from disturbances arising from RF signals. However, certain parts of electronic equipment are not shielded from RF signals produced by your cellular phone.

Pacemakers

The Medical Accessories Manufacturers Association recommends people with pacemakers to maintain a minimal distance of 15 centimeters between the antenna of a cellular phone and a pacemaker to prevent a possible disturbance to the action of the pacemaker. These recommendations are consistent with the recommendations of independent research and cellular technology research.

Hearing Aids

Some digital wireless devices may interfere with hearing aids. In the event of such interference, consult the manufacturer of the hearing device regarding alternative possibilities.

Other Medical Standards

If you tend to use other personal medical devices, consult the manufacturer of the device in order to determine if it is protected from external RF energy. Your physician may also be able to assist you in obtaining this information.

Turn off your cellular device when you enter a medical site according to instructions posted there that instruct you to do so. In hospitals or in other medical facilities equipment is often used that may be sensitive to external RF energy.

Vehicles

RF signals are liable to influence improperly installed electronic systems or systems in motorized vehicles that are inadequately protected. Consult your vehicle manufacturer or its representative. Make sure to always confer with the manufacturer of any item of equipment that you add to your vehicle.

Facilities with Warning Signs

Make sure to turn off your phone in any facility that posts warning signs requiring you to do so.

Explosive Atmospheres

To prevent involvement in explosions, turn off your phone in "explosive" areas or in areas with "Turn off your radio device" signs. Ensure compliance with all signs and instructions.

Potentially Explosive Areas

When you are in an area where the atmosphere is explosive (potentially explosive), turn off your phone device.

These areas are often indicated (though not always). Included are fuelling areas for vehicles, (gas stations), below decks on boats, fuel or chemical transfer or storage facilities, areas where the air contains chemical substances (or particles, granules, dust or metal powders), and any other area where you would be advised to turn off your vehicle engine.

For Vehicles with an Installed Air Bag

An air bag inflates with great force. Do not place objects, including parts of installed equipment or portable equipment in the area of the air bag, or in its deployment area. Portable equipment for the vehicle that is installed defectively in close proximity to an air bag that inflates is liable to cause severe injuries.

Operating temperature

When using Booster or operating from battery: -20oC to +50oC.

When operating from external DC, without booster: -20oC to +60oC.

In any mode of operation, the charging Temp range is -5oC to +45oC.



Wireless Phone Safety Tips

Your Motorola M800 Bag Phone gives you the powerful ability to communicate almost anywhere, anytime, wherever wireless phone service is available and safety conditions allow. But an important responsibility accompanies the benefits of wireless phones, one that every user must uphold while using them.

If you find it necessary to use your M800 Bag Phone while behind the wheel of a car, practice good common sense and remember the following tips:

1. **Get to know your Motorola M800 Bag Phone and its features such as speed dial and redial.** If available, these features help you to place your call without taking your attention off the road.
2. **Let the person you are speaking with know you are driving; if necessary, suspend the call in heavy traffic or hazardous weather conditions.** Rain, sleet, snow, ice, and even heavy traffic can be hazardous.
3. **If you receive an incoming call at an inconvenient time do not take notes or look up phone numbers while driving.** Jotting down a "to do" list or going through your address book takes attention away from your primary responsibility - driving safely.
4. **Dial sensibly and assess the traffic; if possible, place calls when you are not moving or before pulling into traffic.** Try to plan calls when your car will be stationary. If you need to make a call while moving, dial only a few numbers, check the road and your mirrors, then continue.
5. **Do not engage in stressful or emotional conversations that may distract your attention.** Make people you are talking with aware you are driving and suspend conversations which have the potential to divert your attention away from the road.
6. **Use your M800 Bag Phone to call for help.** Dial the appropriate emergency number in the case of fire, traffic accident or medical emergency.*
7. **Use your M800 Bag Phone to help others in emergencies.** If you see an auto accident, crime in progress or other serious emergency where lives are in danger, call the emergency number, as you would want others to do for you.*
8. **Call assistance services, like towing services, or non-emergency assistance services.** If you see a broken-down vehicle posing no serious hazard, a broken traffic signal, a minor traffic accident where no one appears injured, or a vehicle you know to be stolen, call assistance services that provide assistance in non-emergency events.

* Wherever wireless phone service is available.